

TEST SQUARE

Should measure
5cm x 5cm / 2" x 2"
when printed correctly

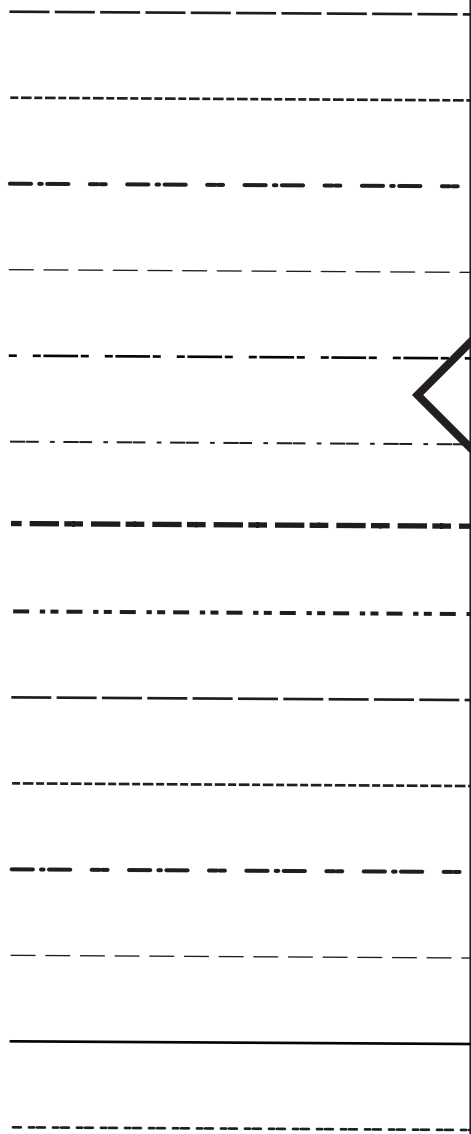

LENGTHEN / SHORTEN

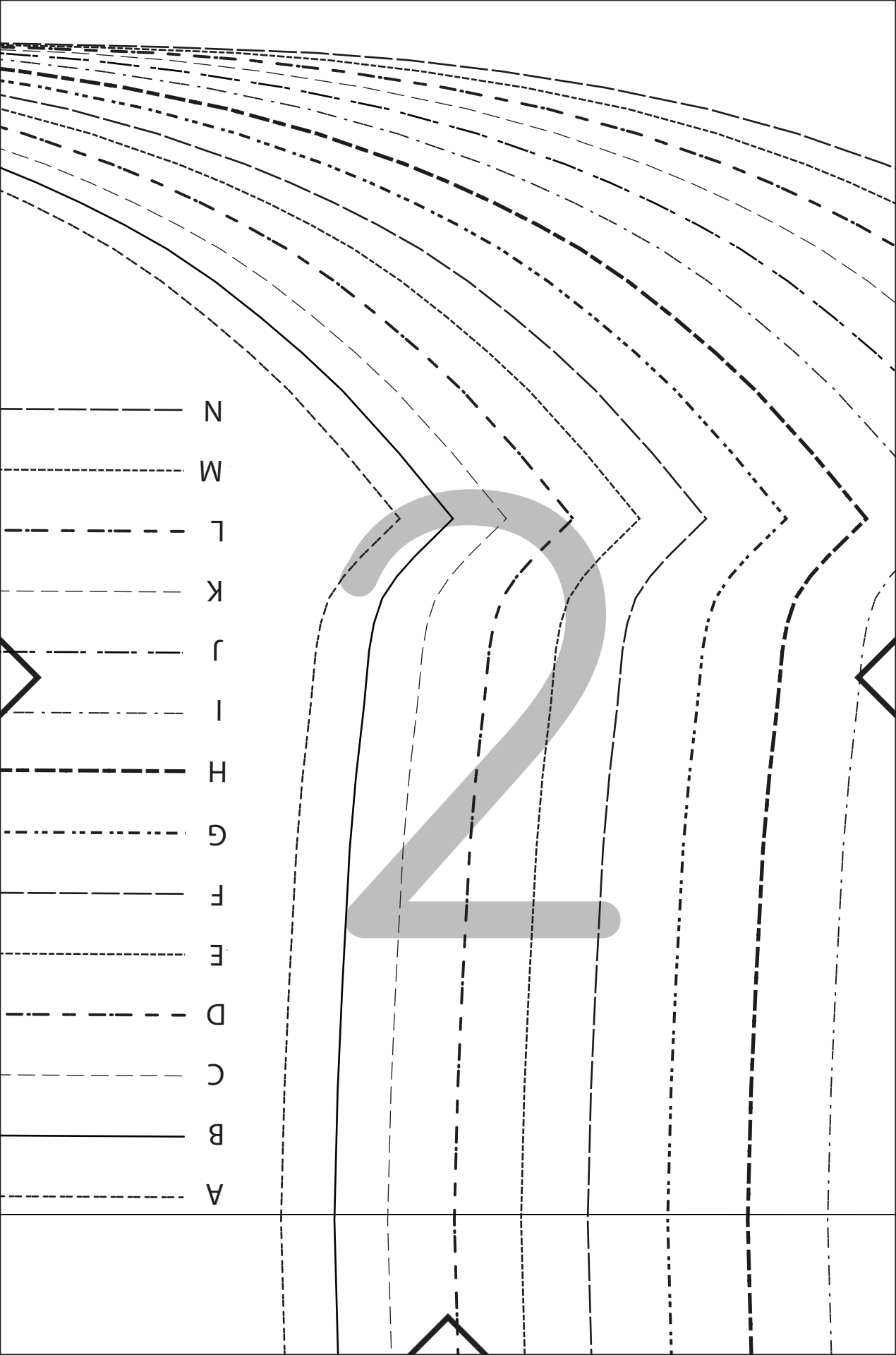

N

W

L

K

J

I

H

G

F

E

D

C

B

A

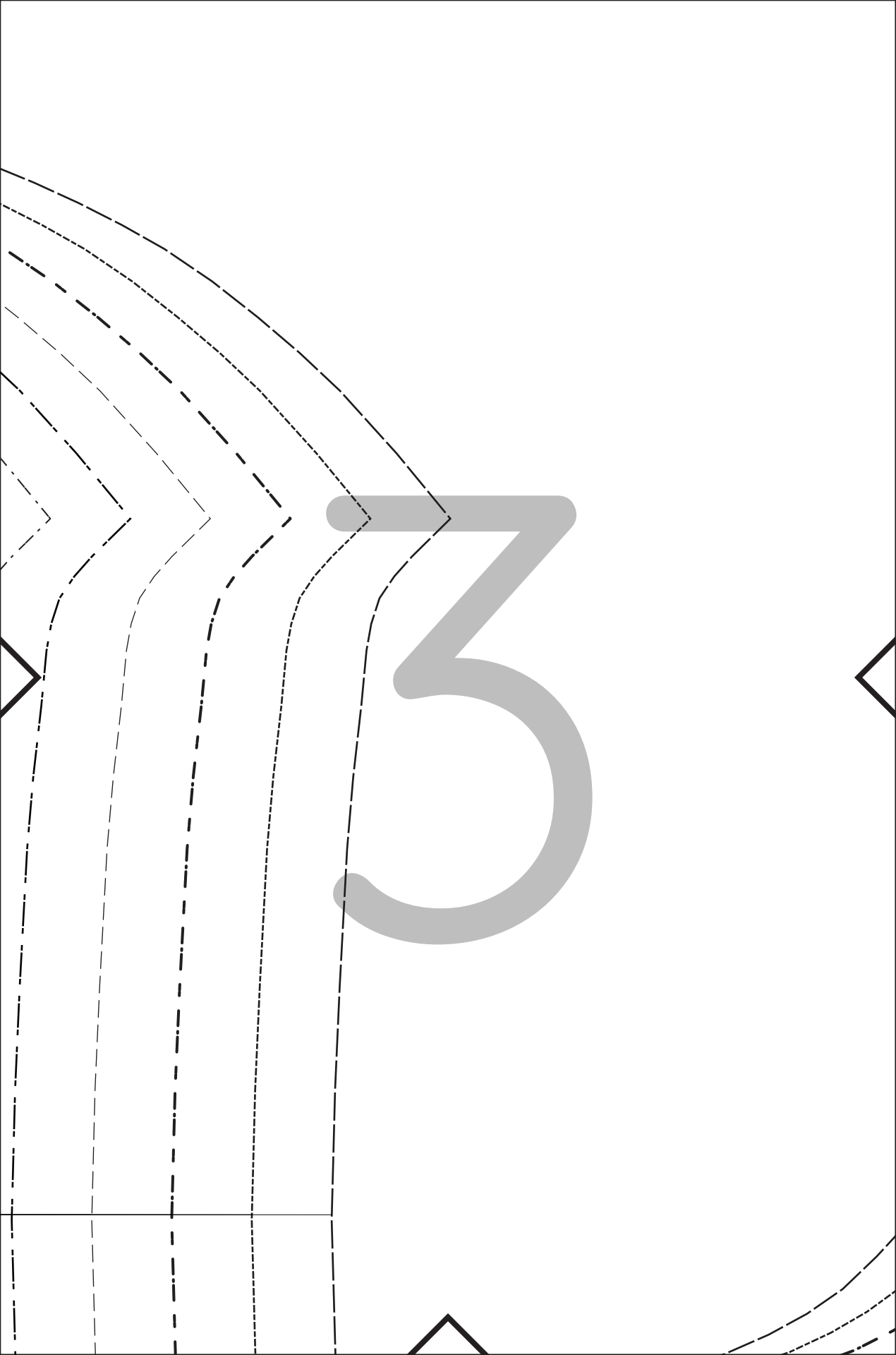

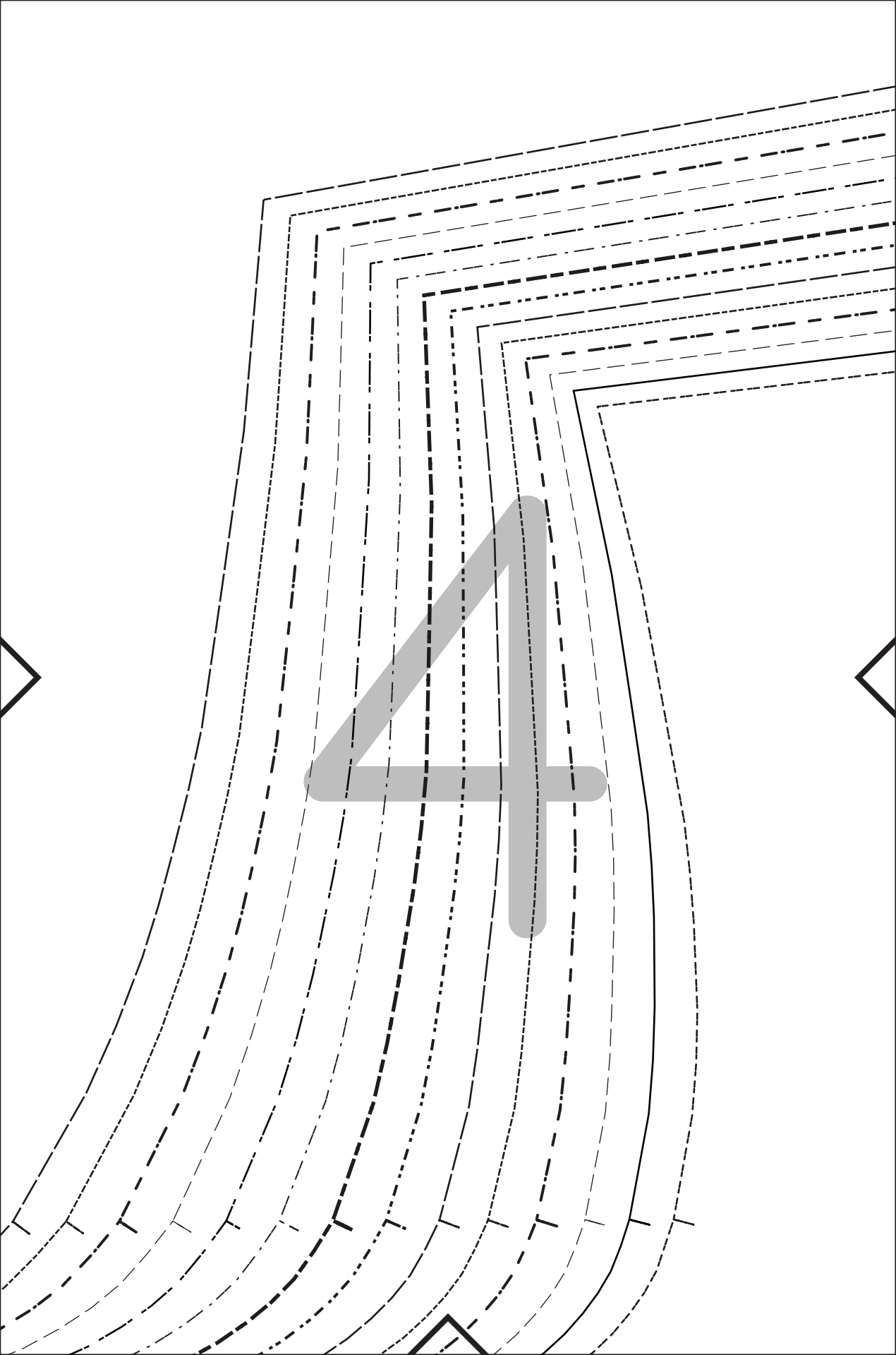

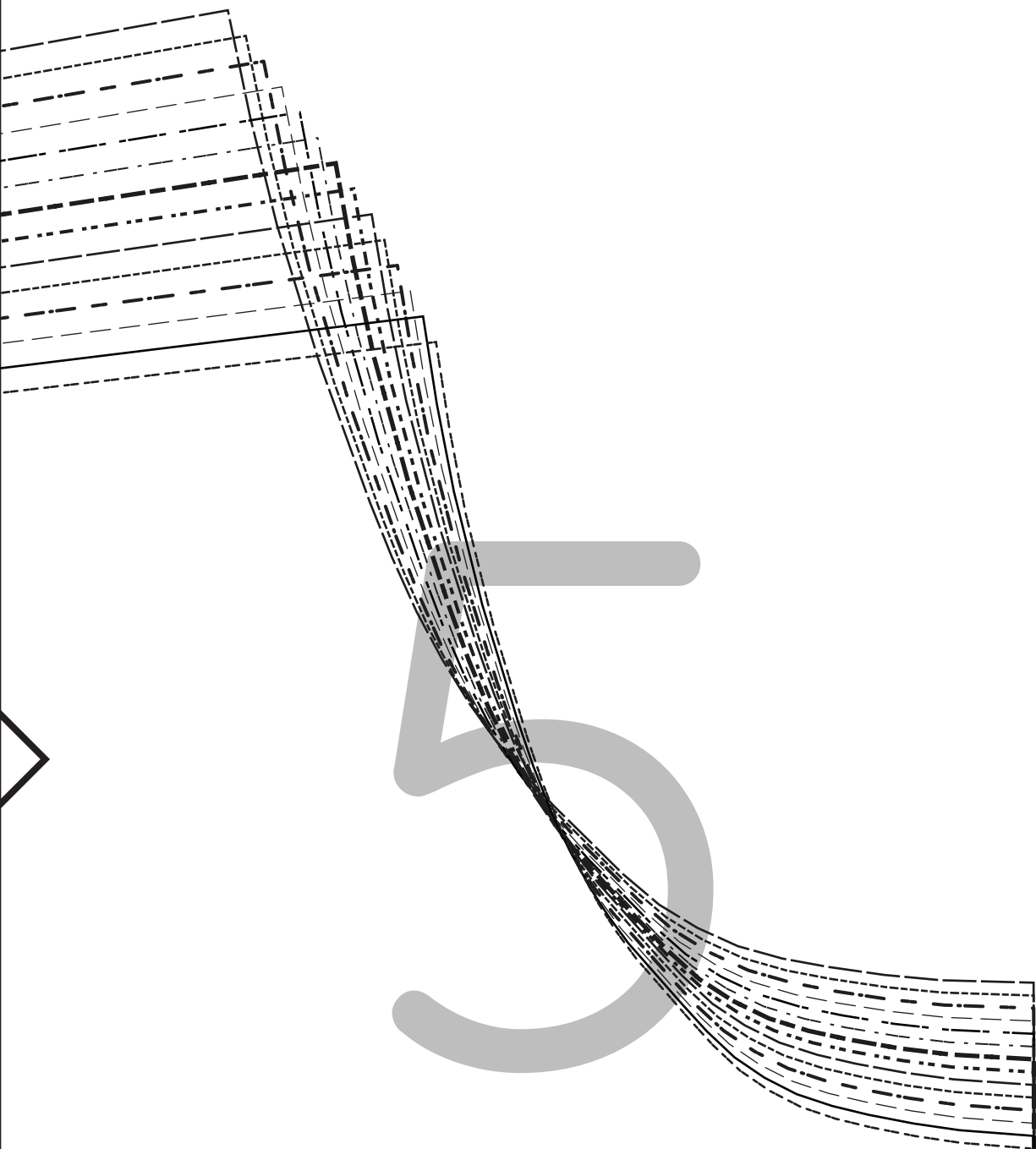

1



CUT X 1 ON FOLD

BACK

THE STELLAN TEE

franchinomy
PATTERNS

2

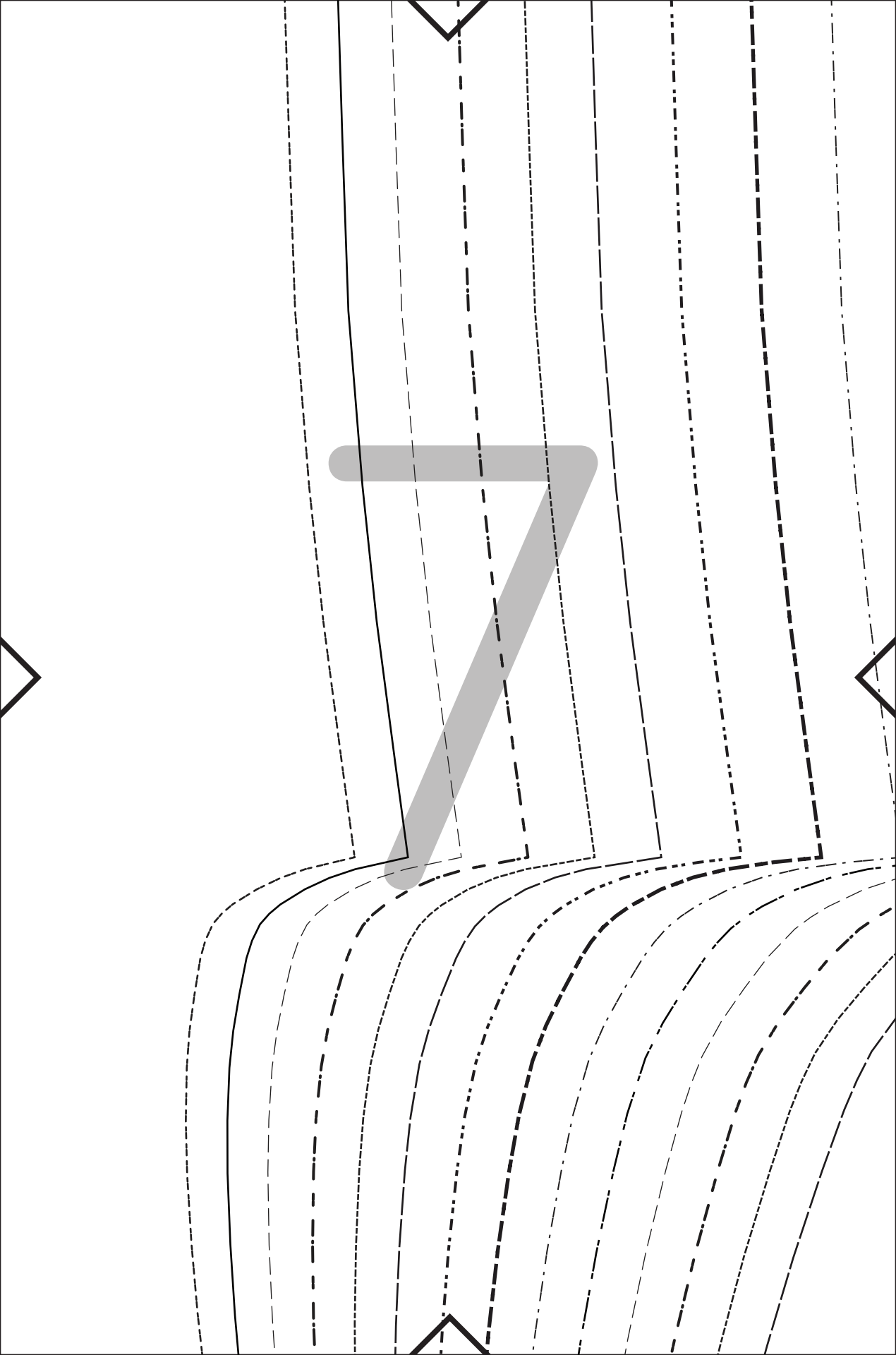

8

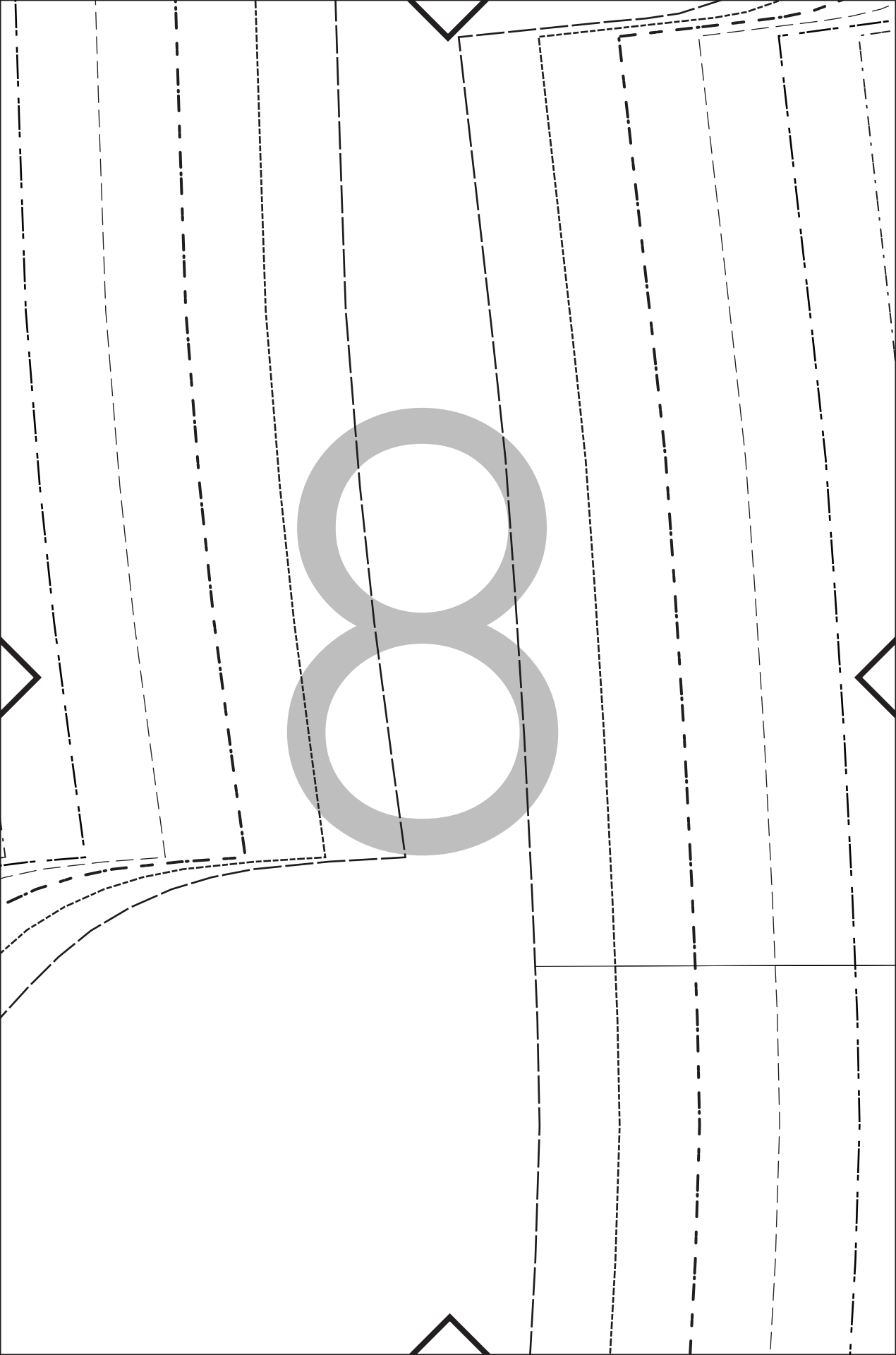

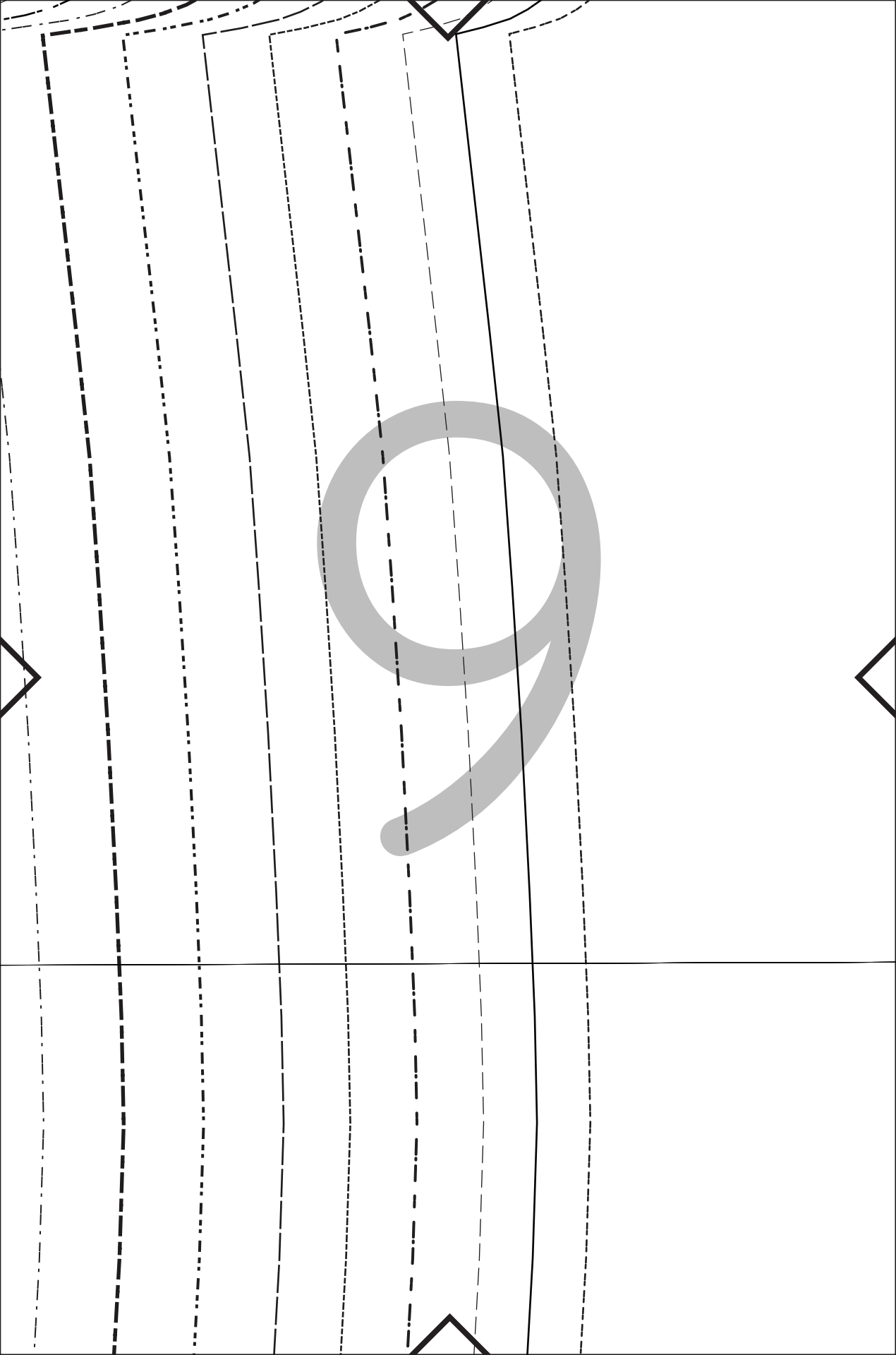

THE STELLAN TEE

FRONT

CUT X 1 ON FOLD



LENGTHEN / SHORTEN

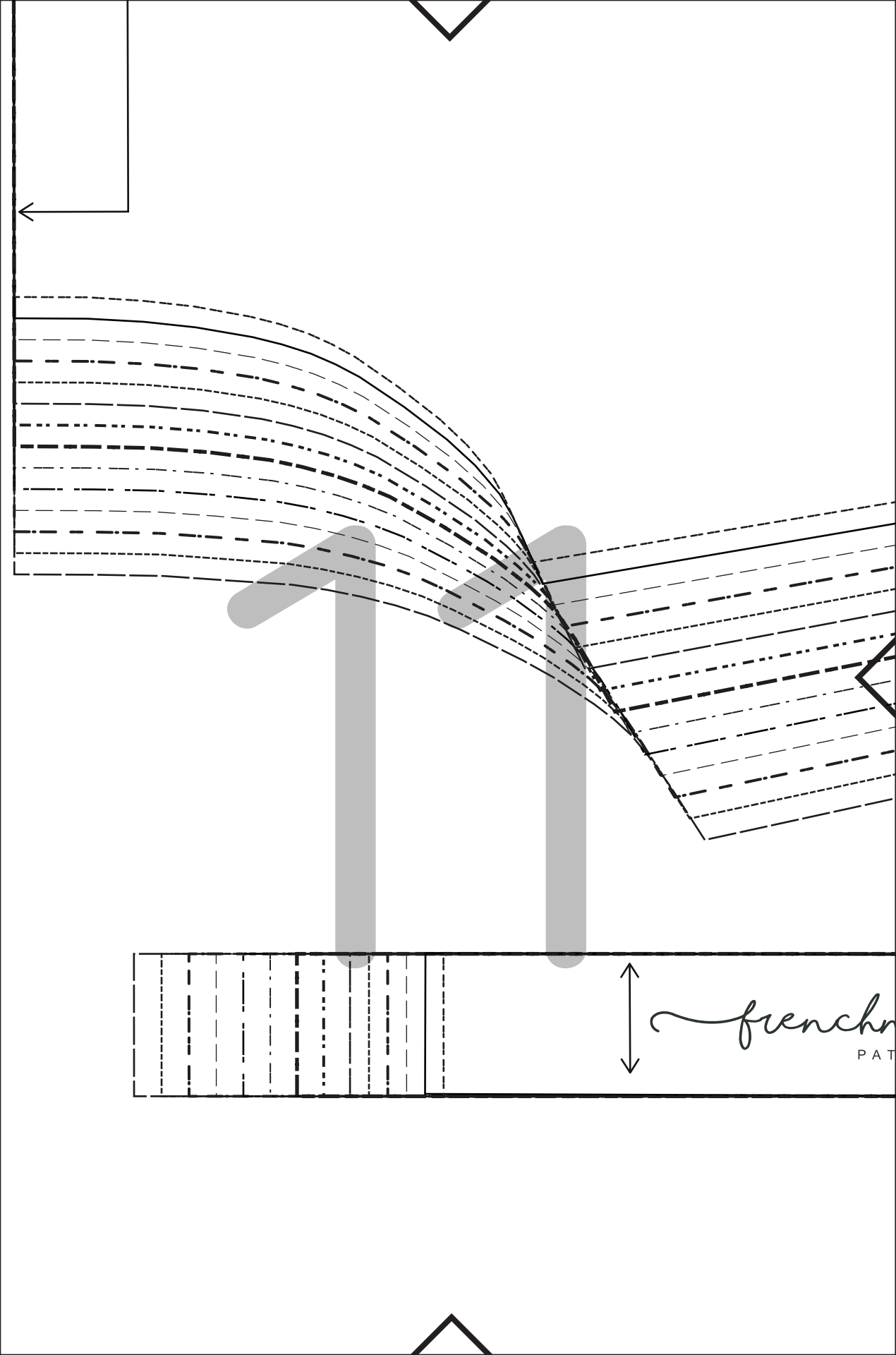

french

PAT

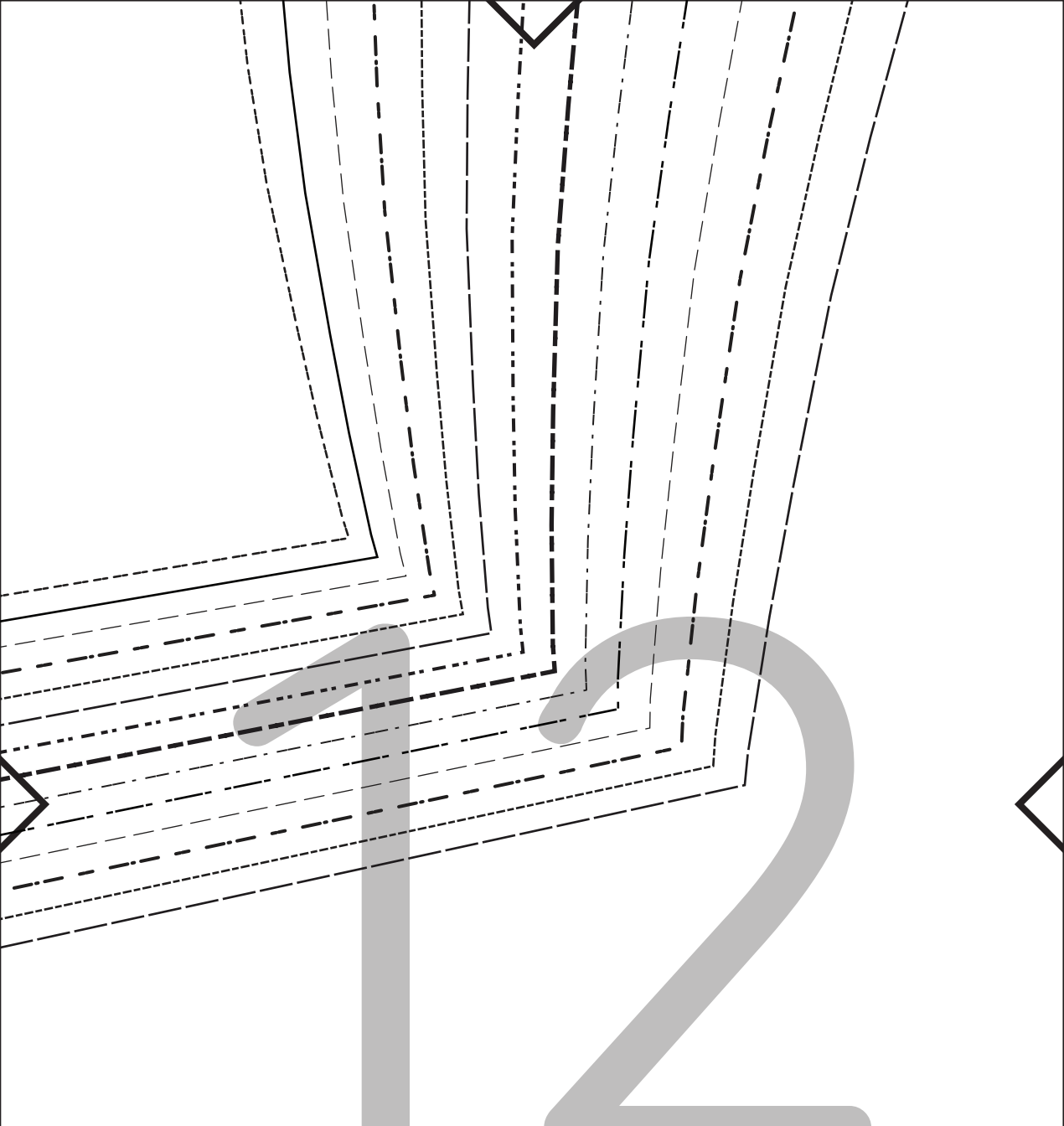

THE STELLAN TEE

NECK REINFORCEMENT

CUT X 1

navy
TERNS

13

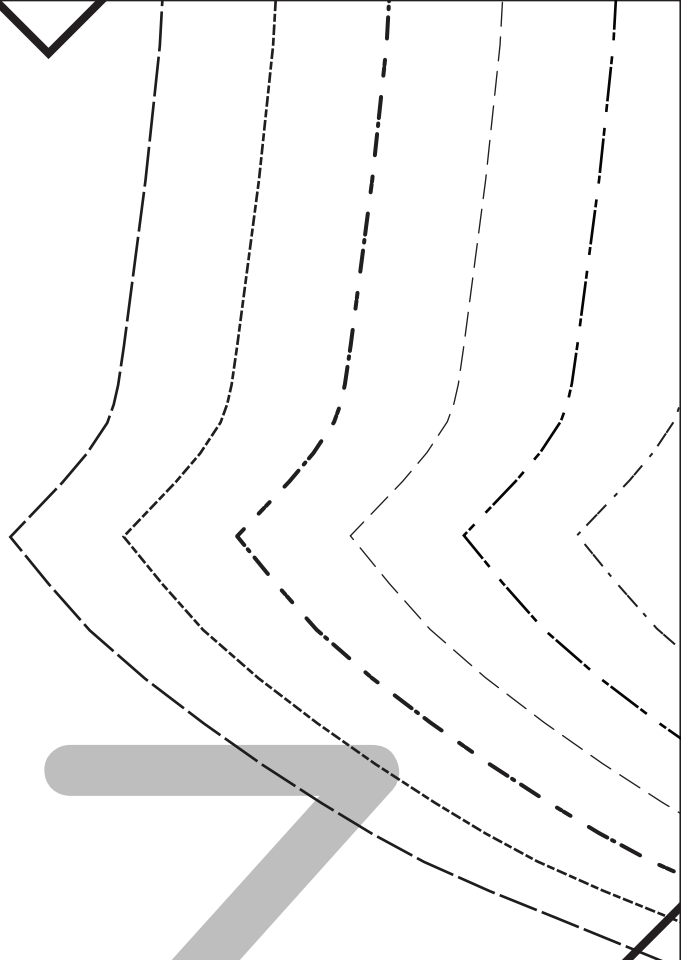

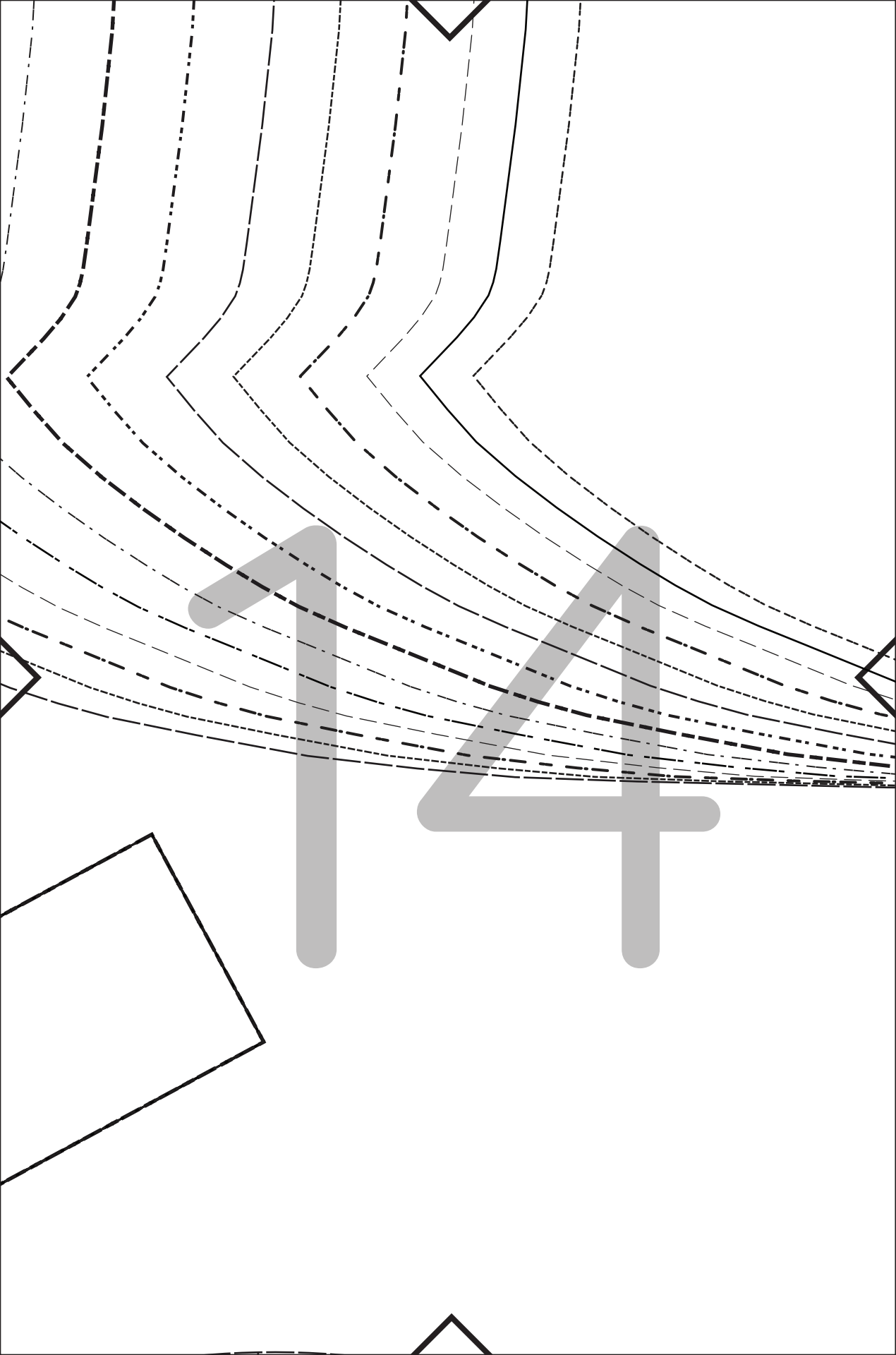

15



16

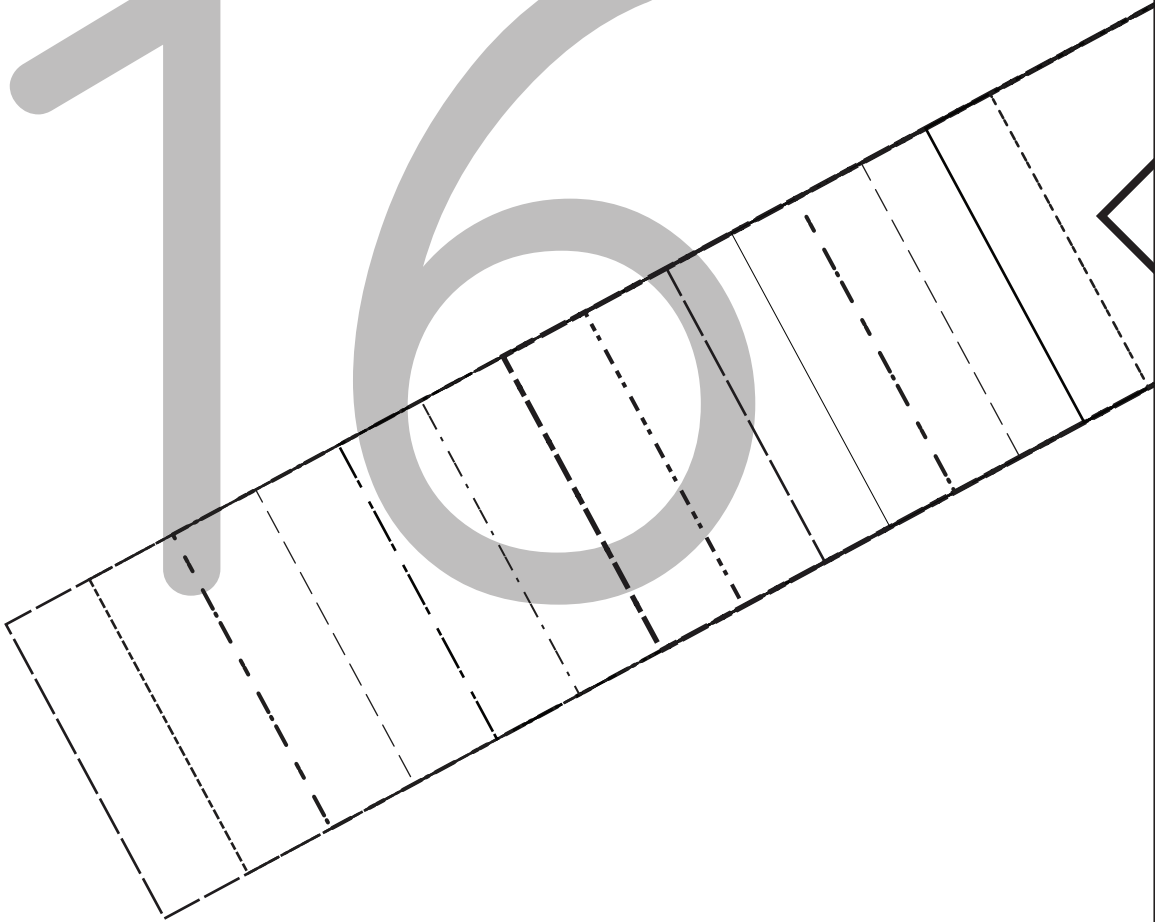

TH

4

frenchnavy
PATTERNS

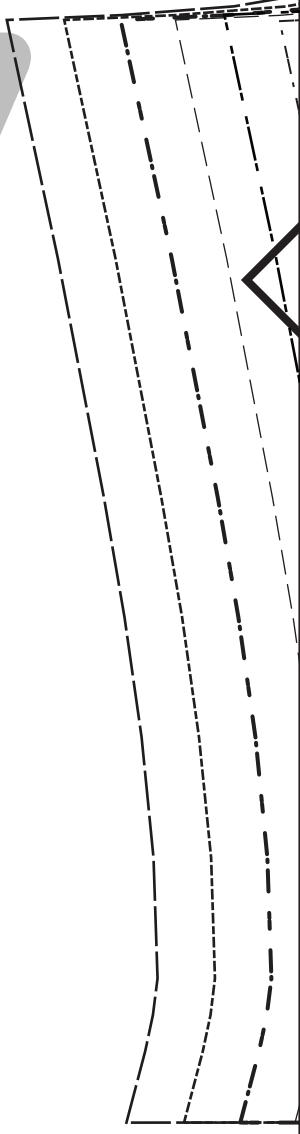
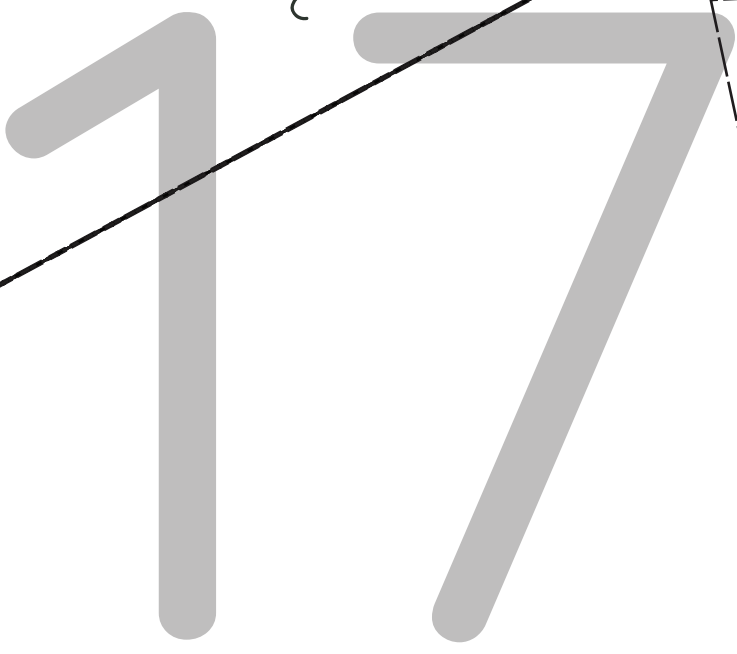
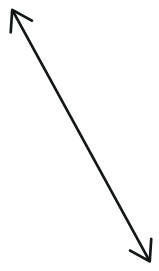

THE STELLAN TEL
NECK BINDING
CUT X 1

18

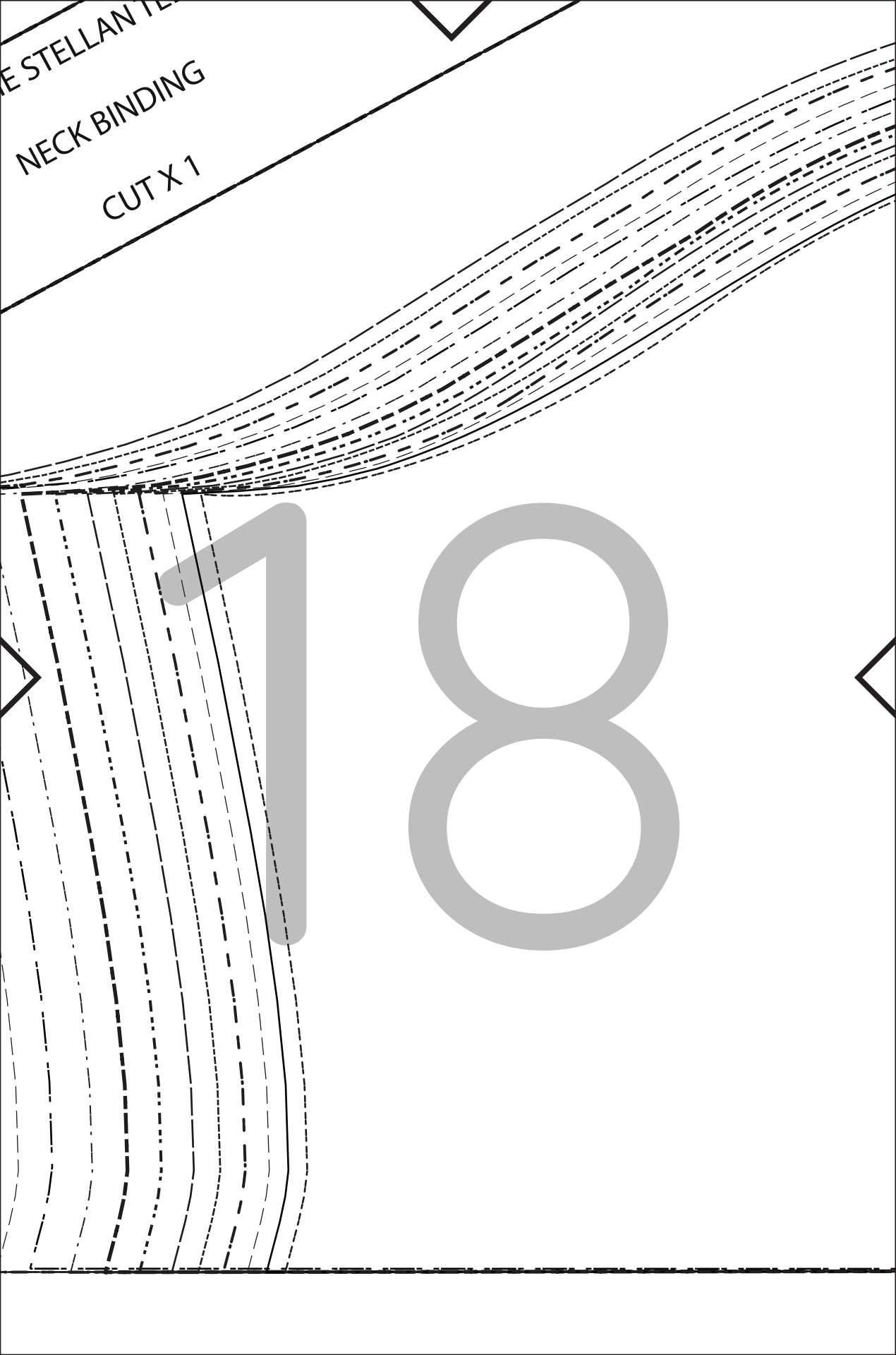



3

19

frenchnavy
PATTERNS

THE STELLAN TEE

SLEEVE

CUT x 2

